

LINEA PLEXY SOSPESA

Segnaletica

SCHEMA TECNICA



STRUTTURA

 MATERIALE TARGA: plexiglass

 FINITURA: trasparente

 MATERIALE DISTANZIALE: ottone/acciaio

 FINITURA: silver satinato

 INDOOR

 FISSAGGIO A SOFFITTO

GRAFICA

 GRAFICA INTERCAMBIABILE

 MONOFACCIALE

 BIFACCIALE

Targa sospesa linea PLEXY realizzata in plexiglass trasparente piegato ad U per la gestione di grafiche cartacee intercambiabili. Aletta laterale per il fissaggio a soffitto con distanziali in ottone finitura silver satinato e cavetti in acciaio. Clip di chiusura trasparente.

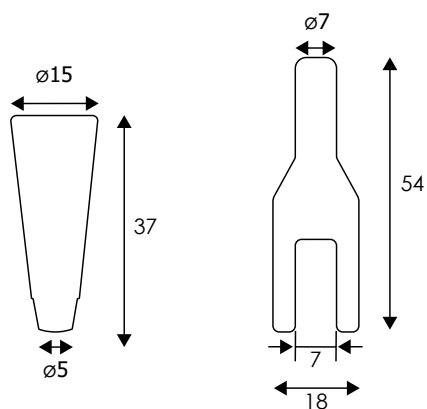
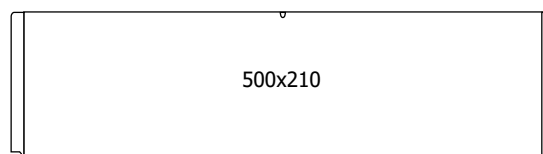
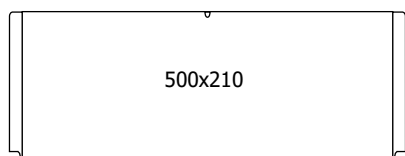
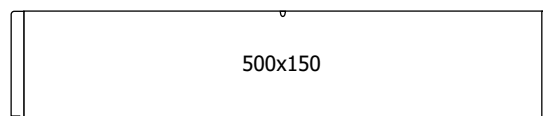
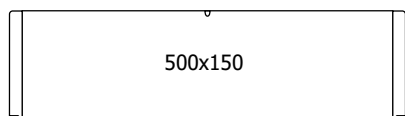
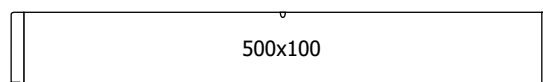
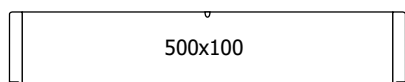
DIMENSIONI PRODOTTO (mm)

| Codice | Area visibile | Dim. struttura (AxB) | Cod. EAN |
|------------------|---------------|----------------------|---------------|
| DIST31/SS | - | 150 X 50 X 37 | 0768855779037 |
| DIST32/SS | - | 180 X 70 X 54 | 0768855779044 |
| LPS5010 | 500X100 | 540X115 | 0768855779051 |
| LPS5015 | 500X150 | 540X165 | 0768855779068 |
| LPS7010 | 700X100 | 250X115 | 0768855779075 |
| LPS7015 | 700X150 | 740X165 | 0768855779082 |
| LPS5021 | 500X210 | 540X225 | 0768855779099 |
| LPS7021 | 700X210 | 740X225 | 0768855779105 |