

LINEA PLEXY SOSPESA

Segnaletica

SCHEDA TECNICA



STRUTTURA

 MATERIALE TARGA: plexiglass

 FINITURA: trasparente

 MATERIALE DISTANZIALE: ottone/acciaio

 FINITURA: silver satinato

 INDOOR

 FISSAGGIO A SOFFITTO

GRAFICA

 GRAFICA INTERCAMBIABILE

 MONOFACCIALE

 BIFACCIALE

Targa sospesa linea PLEXY realizzata in plexiglass trasparente piegato ad U per la gestione di grafiche cartacee intercambiabili. Aletta laterale per il fissaggio a soffitto con distanziali in ottone finitura silver satinato e cavetti in acciaio. Clip di chiusura trasparente.

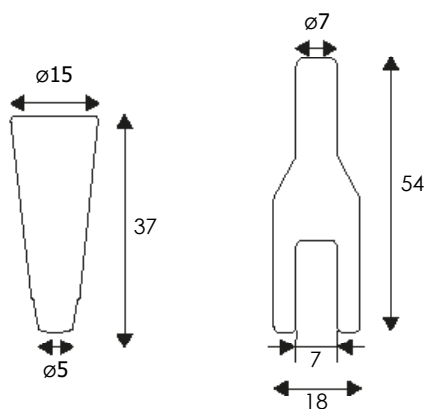
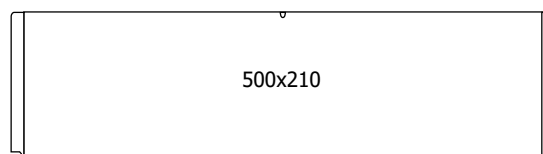
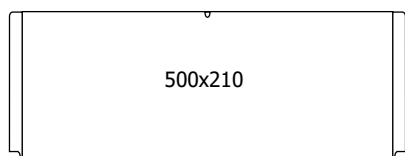
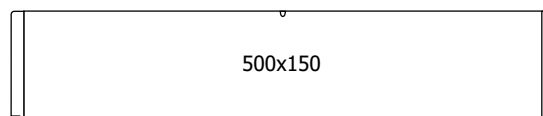
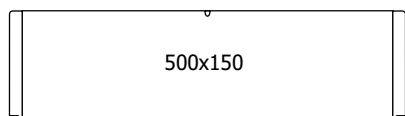
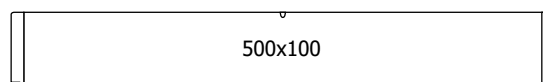
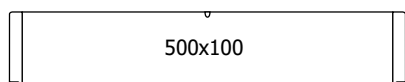
DIMENSIONI PRODOTTO (mm)

Codice	Area visibile	Dim. struttura (AxB)	Cod. EAN
DIST31/SS	-	150 X 50 X 37	0768855779037
DIST32/SS	-	180 X 70 X 54	0768855779044
LPS5010	500X100	540X115	0768855779051
LPS5015	500X150	540X165	0768855779068
LPS7010	700X100	250X115	0768855779075
LPS7015	700X150	740X165	0768855779082
LPS5021	500X210	540X225	0768855779099
LPS7021	700X210	740X225	0768855779105