

SLV01-02-03-05-06-09-10-11/N

Espositori Pubblicitari

SCHEDA TECNICA

1/3A4



SLV03

SLV03/N

A4



**SLV05
SLV05/N**



**SLV06
SLV06/N**



**SLV01
SLV01/N**



**SLV10
SLV10/N**

A5



**SLV09
SLV09/N**



**SLV11
SLV11/N**



**SLV02
SLV02/N**

STRUTTURA



MATERIALE STRUTTURA: alluminio/metallo



FINITURA MONTANTE: anodizzato silver



FINITURA BASE: verniciata silver RAL 9006



FINITURA MONTANTE E BASE: verniciato nero RAL 9005



MATERIALE PORTA DEPLIANT: styrene



INDOOR

Espositore porta depliant a pavimento composto da base circolare in metallo verniciata a polveri silver o nera con diametro 350 mm. Montante in alluminio anodizzato silver o verniciato a polveri nero diametro 30 mm. Porta depliant in styrene trasparente mono o multitasca disponibile nei formati A4, A5, 1/3 A4.

SLV01-02-03-05-06-09-10-11/N

Espositori Pubblicitari

SCHEDA TECNICA

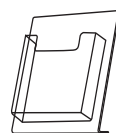
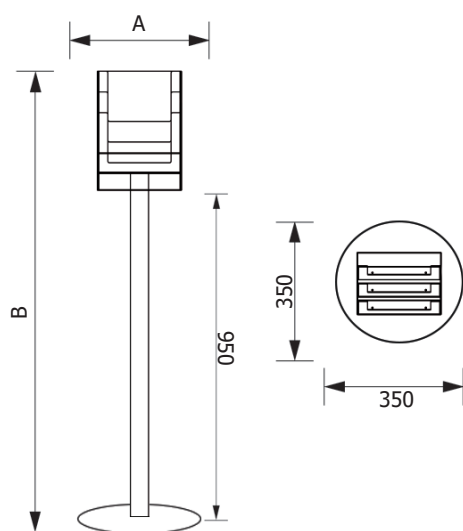
**SLV09**

Dimensioni interne:
160 Larghezza
32 Profondità

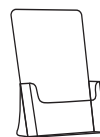
**SLV05**

Dimensioni interne:
210 Larghezza
32 Profondità

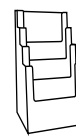
**SLV02**

Dimensioni interne:
160 Larghezza
32 Profondità

**SLV11**

Dimensioni interne:
160 Larghezza
32 Profondità

**SLV06**

Dimensioni interne:
230 Larghezza
32 Profondità

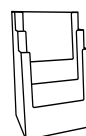
**SLV01**

Dimensioni interne:
230 Larghezza
32 Profondità

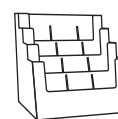
**SLV03**

Dimensioni interne:
330 Larghezza
32 Profondità

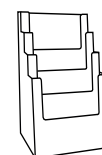
**SLV10**

Dimensioni interne:
230 Larghezza
32 Profondità

DIMENSIONI PRODOTTO (mm)

Codice	F.to tasche	N. Tasche	Dim. tasche	Dim. struttura (AxB)	Cod. EAN
SLV09	A5	1	222x300x95	350x1110	0755899242825
SLV11	A5	3	166x218x110	350x1160	0768855771789
SLV02	A5	4	166x256x155	350x1160	0755899242757
SLV03	1/3 A4	12	340x345x175	350x1150	0755899242764
SLV05	A4	1	220x200x95	350x1200	0755899242788
SLV06	A4	2	236x285x120	350x1200	0755899242795
SLV01	A4	3	236x339x155	350x1200	0755899242740
SLV10	A4	4	237x340x175	350x1200	0768855771772

DIMENSIONI PRODOTTO (mm)

Codice	F.to tasche	N. Tasche	Dim. tasche	Dim. struttura (AxB)	Cod. EAN
SLV09/N	A5	1	222x300x95	350x1110	0768855794061
SLV11/N	A5	3	166x218x110	350x1160	0768855794078
SLV02/N	A5	4	166x256x155	350x1160	0768855794054
SLV03/N	1/3 A4	12	340x345x175	350x1150	0768855794085
SLV05/N	A4	1	220x200x95	350x1200	0768855794016
SLV06/N	A4	2	236x285x120	350x1200	0768855794023
SLV01/N	A4	3	236x339x155	350x1200	0768855794030
SLV10/N	A4	4	237x340x175	350x1200	0768855794047